

Upsilon

[FI] Asennus- ja huolto-ohje
 [UK] Installation and maintenance instructions
 [SE] Installations- och underhållsinstruktioner

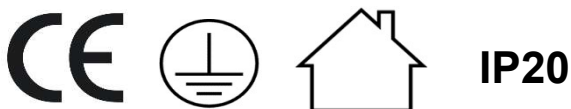
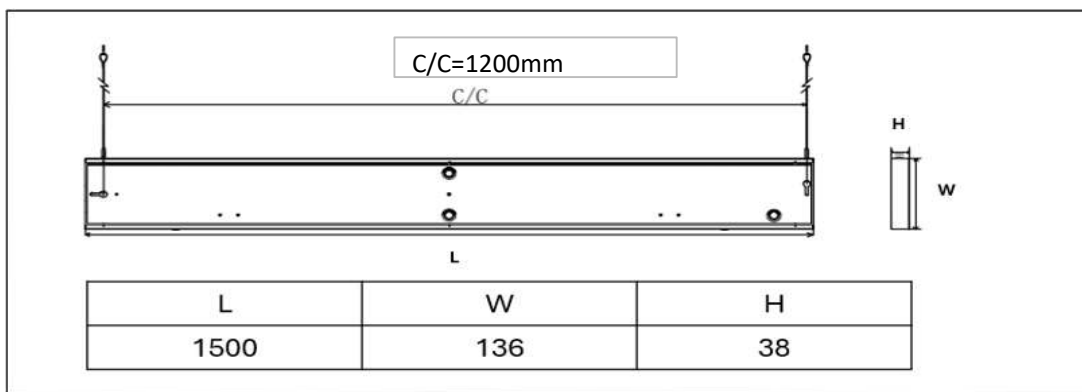
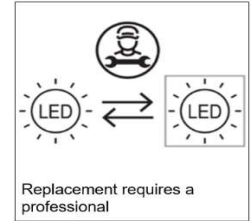
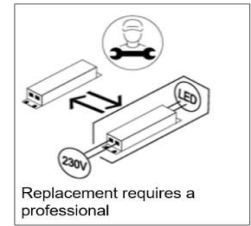
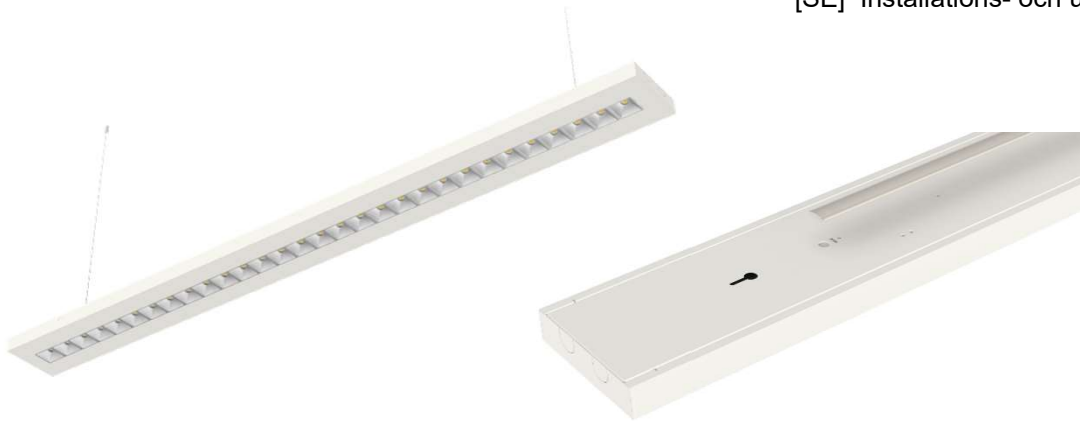

Copyright Greenled Oy

Greenled Oy

Oritkarintie 4

90400 Oulu Finland

p. 020 125 5800

info@greenled.fi

10.4.2024

1. Wiring

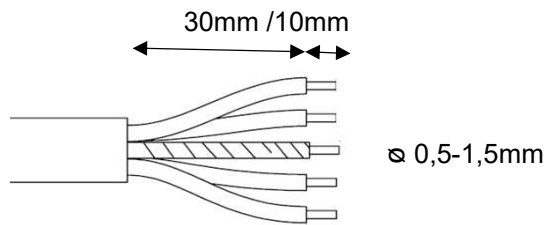

The luminaire is always equipped with a 3.6m 5x0,75mm² connection cable

DALI

- L= Ruskea, Brown, Brun
- N = Sininen, Blue, Blå,
- PE = Kelta-vihreä, Ground wire, Jordledning
- D1= Musta, Black, Svart
- D2= Harmaa, Gray, Grå

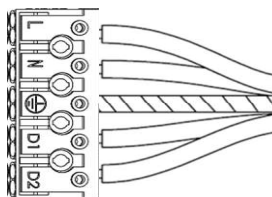

on/off

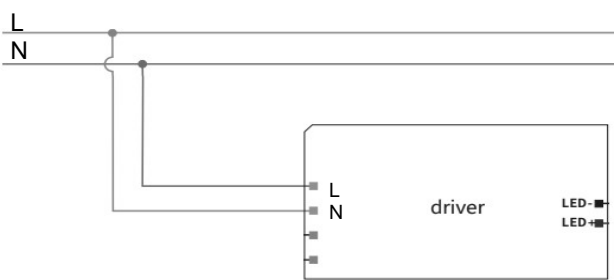

Dali

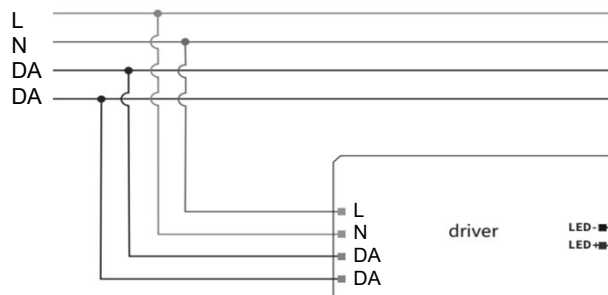

Switch DIM/ push DIM

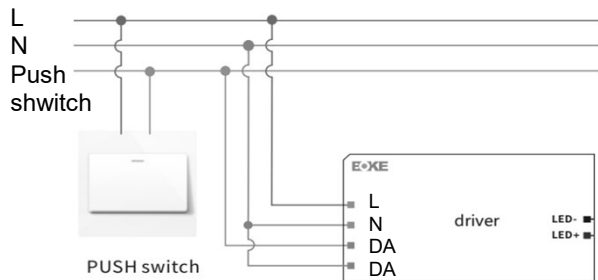

After installation according to the wiring diagram of pushDIM dimming application, short press the pushbutton 1 times or short press the pushbutton 5 times quickly within 3s , the driver will automatically switch to the pushDIM dimming mode. Max. 50 drivers per pushDIM control line.
 Turn on or turn off: short press pushbutton for 0.2-1s.
 Dimming: long press pushbutton for 1-5s.

2. DIP switch

Standard UP/down 39,9W and Direct 33,6W, Prated(w) can be changed as below

Output			1	2	3	4
Prated(w)	Irated(mA)	Voltage(Vdc)				
27.30	650	6-42	--	--	--	ON
33.60	800	6-42	ON	--	ON	--
39.90	1050 ★	6-38	--	--	--	--

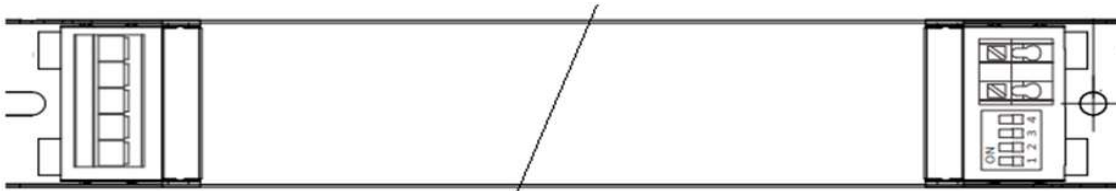

3.1. Suspension instruction for installation

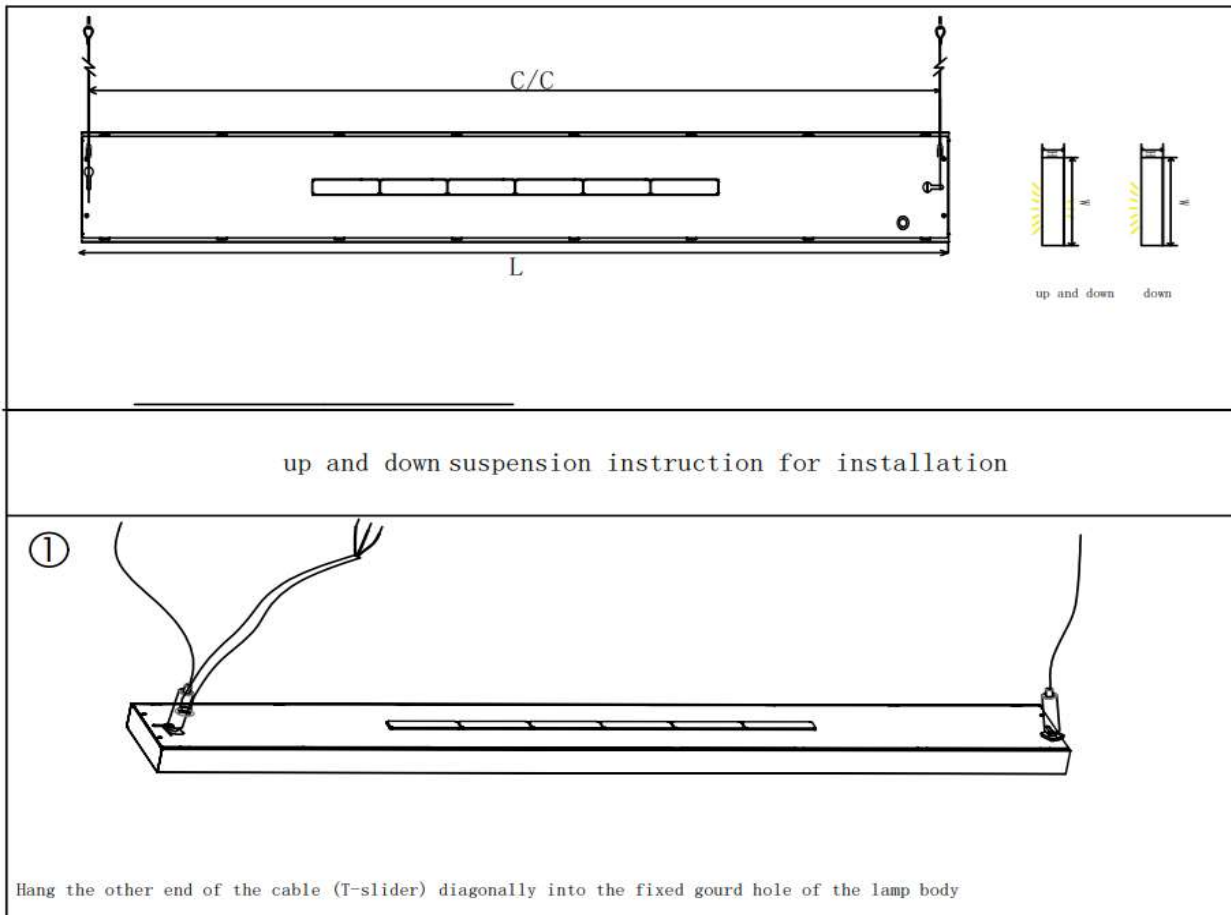

3.2. Surface mounted instruction for installation

①

1. Side stand lamp body, the perforated side faces up, Use a screwdriver with a diameter less than 2.5mm to insert the two holes in the indicator body, press down on the shrapnel, push back at the same time to release the shrapnel and remove the mounting backboard

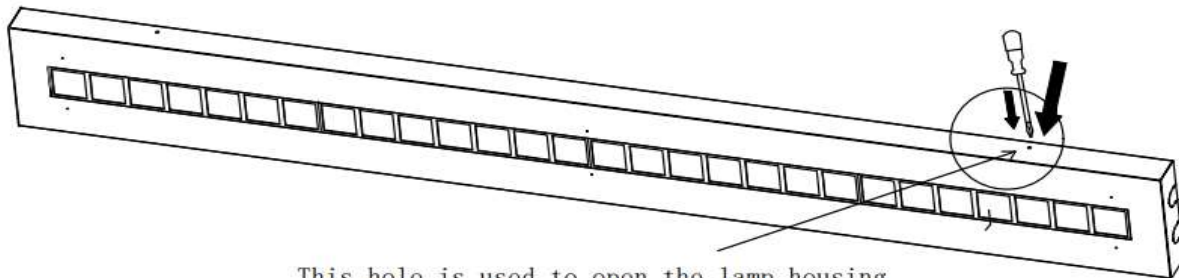

This hole is used to open the lamp housing

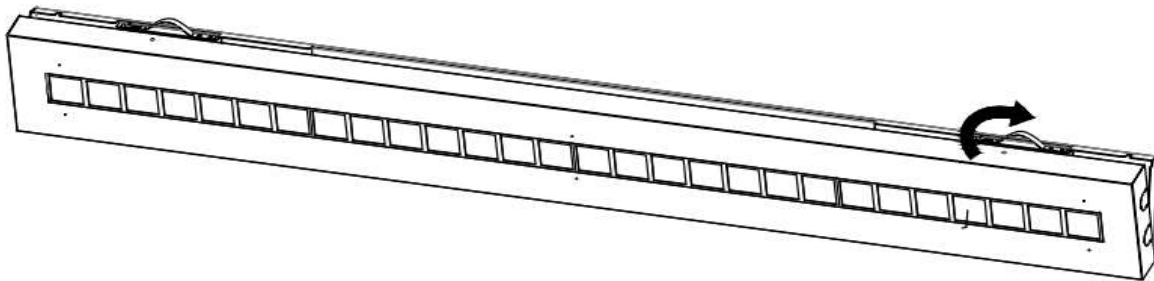

②



Screw in the expansion screws

Drive the expansion screws into the ceiling, that the position of the two screws need in a straight line, and the distance is accurate.



Note: Do not screw in the expansion screw completely

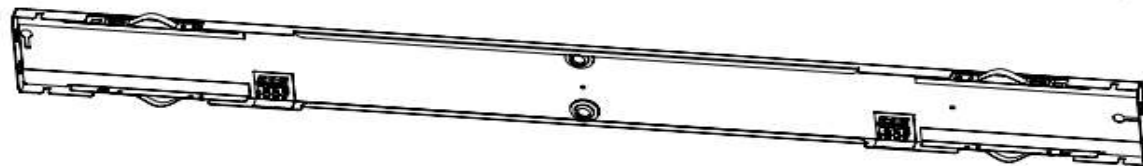

Insert the screw into the hole on the back of the lamp housing, a-b.

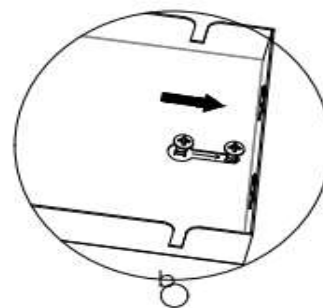
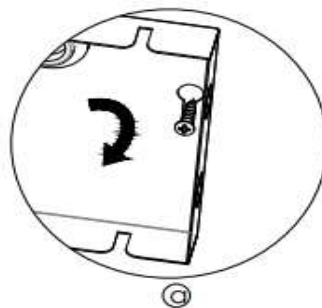

- FI Nämä ohjeet tulee säilyttää ja luovuttaa kiinteistön käyttäjälle.
UK It is appropriate that this information is passed on to the user of the installation.
SE Det är lämpligt att denna information överlämnas till användaren av anläggningen.
-



Turvallisuusvaroitukset:

Ennen asennusta tai huoltotyötä kytke valaisin irti sähköverkosta välttääksesi sähköiskun vaaran!

- Asennus / huoltotyön saa tehdä vain valtuutettu henkilö
 - Valaisimen asennuksen / huoltotyön saa suorittaa vain pätevä henkilö näiden ohjeiden mukaisesti.
 - Valmistaja ei kannu vastuuta valaisimen väärästä käytöstä
 - Älä katso suoraan päällä olevaan valaisimeen
 - Valaisimen valonlähteen saa vaihtaa ainoastaan Greenled, Greenledin valtuuttama huoltaja tai vastaavan pätevyyden omaava henkilö
-

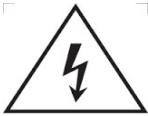

Safety notes:

Before installation or change work disconnect the power to reduce electrical shock risk!

- Installation / maintenance can only be done by a skilled personnel
 - Installation / maintenance of luminaire must be performed by qualified person following the instructions given in the instruction set
 - The manufacturer bears no liability for damage caused by inappropriate use or application
 - Do not stare at the operating light source
 - The light source contained in this luminaire shall only be replaced by the Greenled or Greenled's service agent or a similar qualified person
-

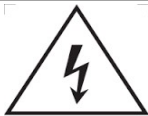

Säkerhetsvarningar:

Koppla alltid bort armaturen från elnätet i samband med installation ti den som använder armaturen.

- Installations- och underhållsarbeten får endast utföras av en behörig installatör
 - Installations-/underhållsarbetet får endast utföras enligt dessa anvisningar av en person med tillräckliga kunskaper
 - Tillverkaren ansvarar ej för felaktig användning av armaturen
 - Titta aldrig rakt in i en påslagen armatur
 - Ljuskällan inuti armaturen får endast bytas av antingen Greenled, en Greenled-auktoriserad servicetekniker eller en person med motsvarande kompetens
-

Copyright Greenled Oy

Greenled Oy

Oritkarintie 4

90400 Oulu Finland

p. 020 125 5800

info@greenled.fi

GREENLED